

• MATERIALS:(RoHS Compliant)

Hood: Plastic Thermoplastic PBT UL 94V-0
 Latch & Hood: Plastic Thermoplastic PBT UL 94V-0
 Latch: Stainless Steel
 Jackscrews: Steel Nickel Plated Over Copper
 Hex Nuts: Steel Nickel Plated Over Copper
 Cable Clipper: Steel Nickel Plated Over Copper
 Screws: Steel Nickel Plated Over Copper

• MATERIALS: (RoHS Compliant)

Housing: Plastic Thermoplastic
 P.B.T UL94V-0 Black
 Contacts: Phosphor Bronze Gold
 Selective Plated
 Front Shell: Steel Nickel Plated Over Copper

• ELECTRICAL CHARACTERISTICS:

Contact Current Rating: 0.5 Amp
 Dielectric Withstanding Voltage: 500V AC
 Insulation Resistance: >500MΩ/Min
 Contact Resistance: 35mΩ/Max
 Operation Temperature: -55°C ~ +85°C

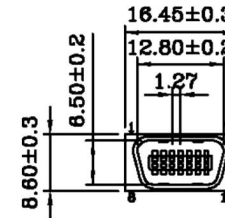
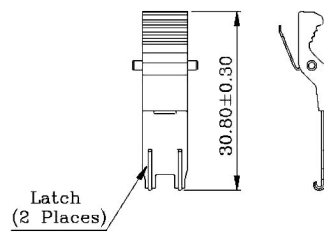
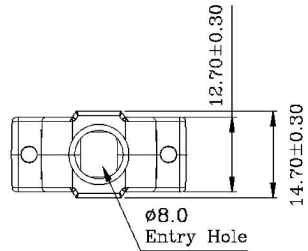

A

B

C

D

E

F

G

H

A

B

C

D

E

F

G

H

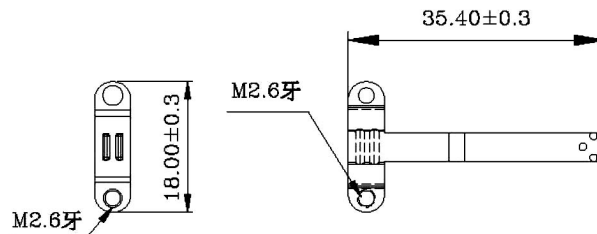
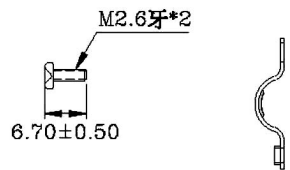
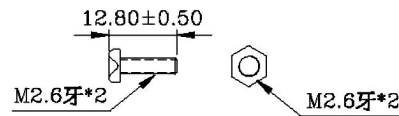
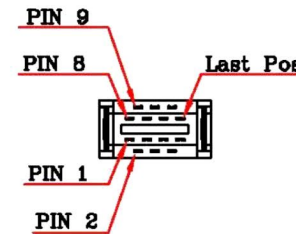
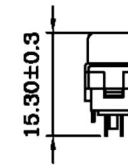
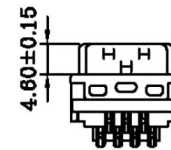
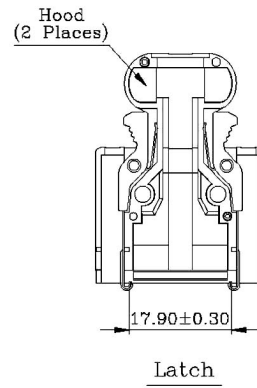
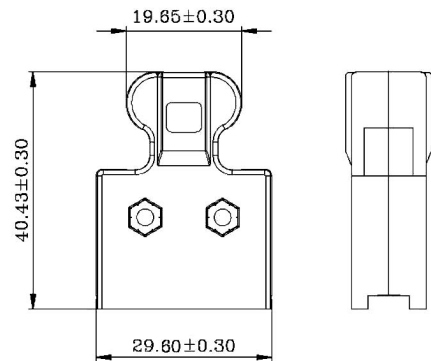

RoHS Compliant		HSM 玄茂科技股份有限公司 HSUAN MAO TECHNOLOGY CO., LTD.	
APPD. 核准 HELEN	SCALE 比例 参考	TOLERANCE 容許公差 .0 ± .00 ± ANG. ±	PART NAME 品名 1.27mm SCSI II GEN. SOLDER CONNECTOR 14P MALE FISH HOOK SPRING LATCHES (STAINLESS STEEL) T=0.3mm ENTRY HOLE SIZE: φ8MM HOOD:BLACK ROHS
DWG. 製圖 ABBY	UNIT 單位 M M	SIZE. 紙張尺寸 A 4	PART NO. 料號 C0510-14MELXB0R
DATE 制表日 2012/08/23	PAGE 張數 1 OF 1	REV. 版次 A	

1

2

3

4

5

6

7

8