

1 2 3 4 5 6 7 8

A

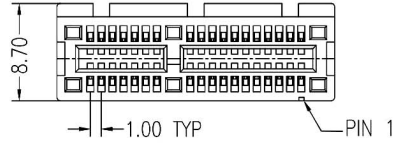

B

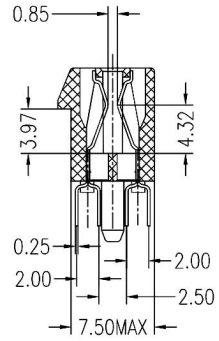

C

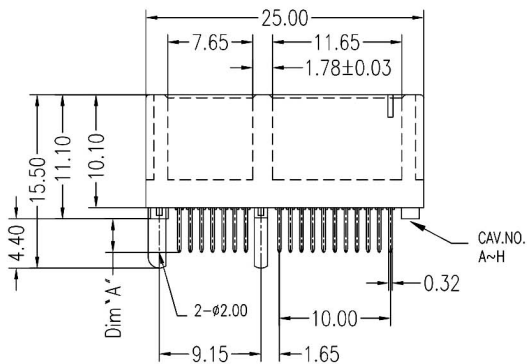

D

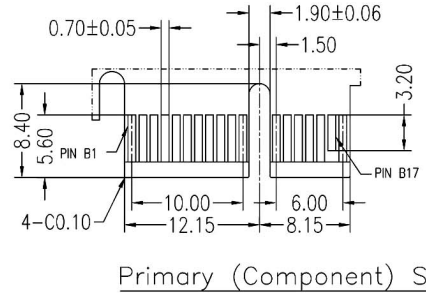

E

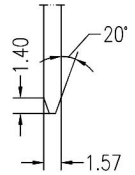

F

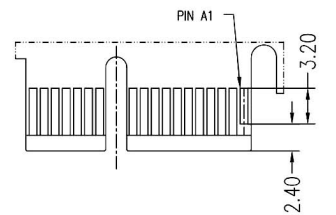

G

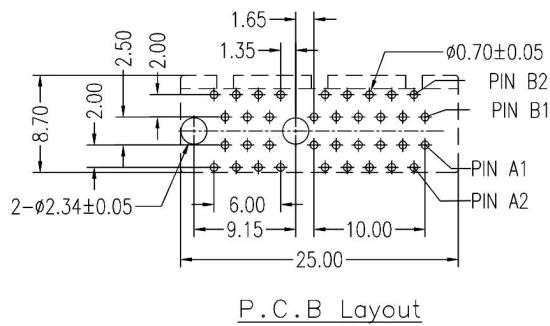

H

NOTES:

1. Material:
 Body: Nylon 46+30%G.F., UL 94V-0 Rated.
 Color: White or Black.
 Contact: Brass.
 Plating: Gold Plating over Nickel on Contact Area.
 Tin Plating on Solder Tail.
2. Mechanical:
 Insertion Force: 1.15N Max per Contact Pair.
 Withdrawal Force: 0.15N Min per Contact Pair.
 Contact Retention Force: 4.9N Min per Contact.
3. Electrical Specification:
 Current Rating: 1.1 Ampere.
 Contact Resistance: 30mΩ Max.
 Insulation Resistance: 1000MΩ Min.
 Dielectric Withstanding Voltage: 500 VAC.
4. Environmental:
 Operating Temperature: -55°C to +105°C

A

B

C

D

E

F

G

H

Part Number	Dim`A`
C3613-36PNBS2BL	2.5mm
C3613-36PNBS3BL	3.0mm

RoHS Compliant		玄茂科技股份有限公司 HSIUAN MAO TECHNOLOGY CO., LTD.	
APPD. 核准 DWG. 製圖 DATE 制表日 2018/04/10	SCALE 比例 參考 UNIT 單位 MM PAGE 張數 1 OF 1	UNLESS OTHERWISE SPECIFIED DIMENSIONS ARE IN MM TOLERANCES ARE: DECIMALS ANGLES .XX ± .25 ± 3° .XXX ± .20 SIZE 紙張尺寸 A 4 REV. 版次 A	PART NAME 品名 1.0mm PCI EXPRESS DIP TYPE (180°) 36P PLASTIC POSTS BODY MATERIAL: NYLON 46 CONTACT MATERIAL: BRASS SELECTIVE GOLD PLATING BLACK COLOR ROHS Soldering Temperature 260°C 5 Seconds PART NO. 料號 C3613-36PNBSXBL

1 2 3 4 5 6 7 8