

1 2 3 4 5 6 7 8

A
B
C
D
E
F
G
H

A
B
C
D
E
F
G
H

3.65±0.15

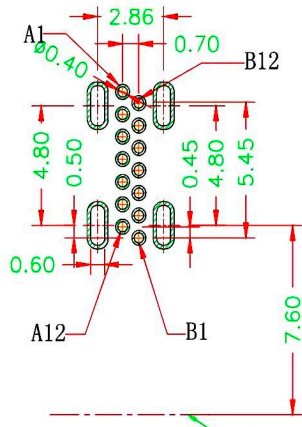
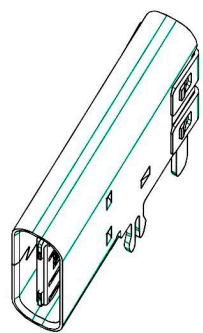
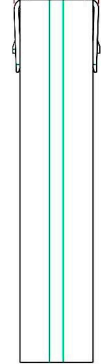

- NOTES:
SPECIFICATION:
1. CURRENT RATING: 3A MAX
 2. VOLTAGE: 100 VAC
 3. TEMPERATURE RANGE: -30 °C ~ 85 °C
 4. CONTACT RESISTANCE: 40 MILLIONHM MAX
 5. INSULATION RESISTANCE: 100 MEGOHMS MIN.
 6. INSERTION FORCE : 5N~20N
 7. UNMATING FORCE: 8N~20N
 8. DURABILITY: 10,000 CYCLES

3.16±0.15

14.55±0.15

RECOMMENDED P.C.B. LAYOUT
TOLERANCE UNSPECIFIED ±0.05mm

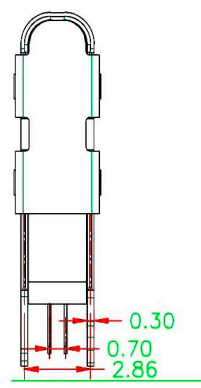
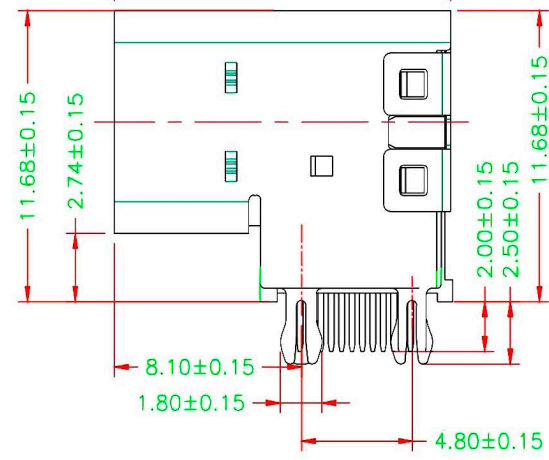
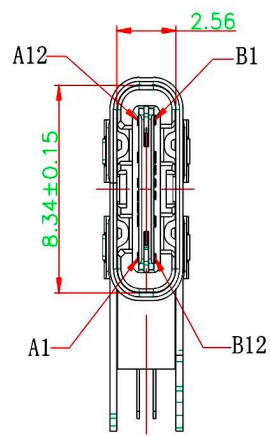

6	SHELL	STAINLESS STEEL	Ni Plated	1PCS
5	SHIELDING PLATE	STAINLESS STEEL	---	1PCS
4	MD	HIGH TEMPERATURE PLASTIC	BLACK	1PCS
3	CONTACT	COPPER ALLOY	Au/Ni Plated	1SET
2	CONTACT	COPPER ALLOY	Au/Ni Plated	1SET
1	HOUSING	HIGH TEMPERATURE PLASTIC	BLACK	1PCS
NO.	DESCRIPTION	MATERIAL	REMARKS	QTY

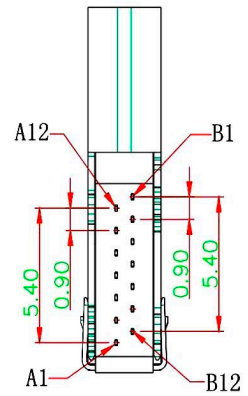

A1	GND	B12	GND
A4	VBUS	B9	VBUS
A5	CC1	B7	DN2
A6	DP1	B6	DP2
A7	DN1	B5	CC2
A9	VBUS	B4	VBUS
A12	GND	B1	GND
PIN	SIGNAL NAME	PIN	SIGNAL NAME

RoHS
Compliant

HSM 玄茂科技股份有限公司
HSUAN MAO TECHNOLOGY CO., LTD.

APPD. 核准
Betty
DWG. 製圖
DATE 制表日
2020/09/08

公 差 TOLERANCE
X ±0.15 (1" ~ ±10")
Y ±0.10 (1/8" ±5")
Z ±0.05 (1/32" ±2")
XXX ±0.02 (1/50" ±1")
SCALE 比例 參考
UNIT 單位 M M
PAGE 張數 1 OF 1
REV. 版次 A

PART NAME 品名
USB Connector Type-C 14Pin Female
Right Angle Type Heighten Type Material:LCP
Selective Gold 1U" Plating Black Color
Tray Packing ROHS
PART NO. C8667-14CFNNBHR
料 號

1 2 3 4 5 6 7 8