

- 1.ELECTRICAL:
- 1)CURRENT VOLTAGE RATING: 5A 20V
 - 2)INSULATION RESISTANCE: 100MΩ MIN.
 - 3)CONTACT RESISTANCE:
LLCR:VBUS & GND PINS AND OTHER PINS: 40mΩ /PIN MAX.
SHIELD:50mΩ /MAX.
LLCR MAX.CHANGE OF ALL PINS: 10mΩ .
 - 4)WITHSTANDING VOLTAGE: 100V AC FOR 1 MINUTE.
 - 5)OPERATING TEMPERATURE:-25°C TO +85°C.
- 2.Mechanical:
- 1)Mating Force: 5N~20N
 - 2)Unmating Force: 6N~20N
 - 3)Durability: 10,000 CYCLES MIN;

RECOMMENDED PCB LAYOUT(TOP VIEW)
DEFAULT TOLERANCE:±0.05

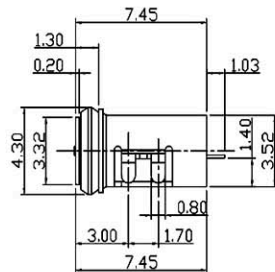
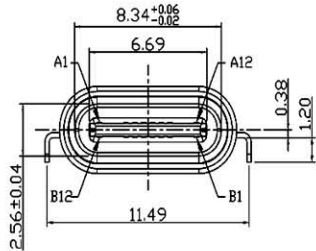
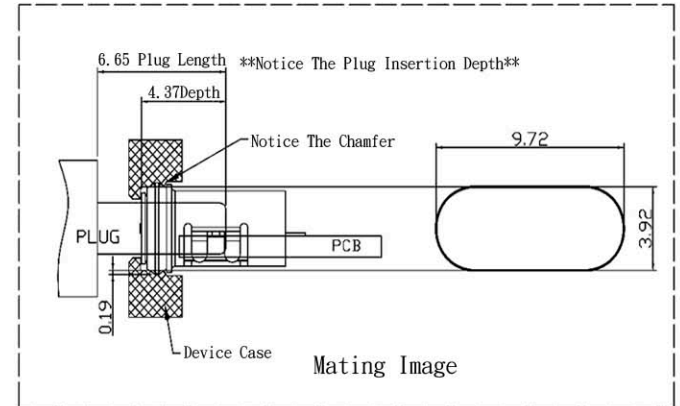
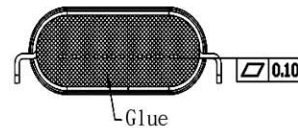

USB TYPE-C PIN ASSIGNMENTS

PIN NUMBER	SIGNAL NAME	PIN NUMBER	SIGNAL NAME
A1	GND	B12	GND
A4	VBUS	B9	VBUS
A5	CC1	B8	SBU2
A6	Dp1	B7	Dn2
A7	Dn1	B6	Dp2
A8	SBU1	B5	CC2
A9	VBUS	B4	VBUS
A12	GND	B1	GND

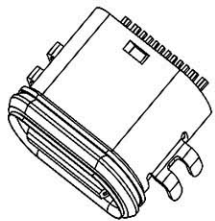
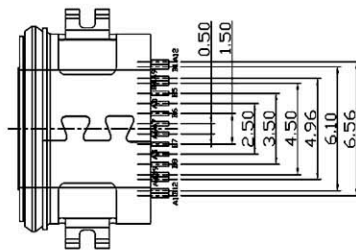

Bill of materials:

NO	PARTS	MATERIAL	QTY	FINISHING
7	WATERPROOF RING	SILICONE RUBBER	1	WHITE
6	EPOXY		1	BLACK
5	OUTER SHELL	STAINLESS STEEL	1	PLATED NICKEL
4	INNER SHELL	STAINLESS STEEL	1	
3	MID PLATE	STAINLESS STEEL	1	
2	CONTACT	COPPER ALLOY	16	PLATED GOLD 1U"
1	HOUSING	PA10T+30%GF	1	UL94V-0
NO	PARTS	MATERIAL	QTY	FINISHING

RoHS
Compliant

HSM 玄茂科技股份有限公司
HSUAN MAO TECHNOLOGY CO., LTD.

APPD. 标准 Betty

DWG. 製圖 Lena

DATE 制表日 2023/3/22

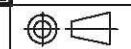

SCALE 比例 参考

UNIT 單位 MM

PAGE 張數 1 OF 1

TOLERANCE
X ±0.50 X° ±2°
X ±0.30 X° ±1°
XX ±0.20 XX° ±0.5°
XXX ±0.05

SIZE 紙張尺寸 A4

REV. 版本 A

PART NAME 品名
USB CONNECTOR TYPE C WATERPROOF TYPE
16PIN FEMALE OFFSET TYPE PIN FOOT:SMT TYPE
SHELL FOOT:DIP TYPE CONTACT AREA:GOLD 1u"
PLATING SOLDER AREA:TIN PLATING BLACK COLOR
REEL PACKING ROHS

PART NO. 料號 C8679-16CFNBR0R